

Panasonic

Proprietary Telephones

Quick Reference Guide

Model **KX-T7720E/KX-T7730E/KX-T7750E**

Important Information

When using the KX-T7700 series, keep the following in mind.

- If there is any problem, unplug the extension and connect a known working phone. If the known working phone operates properly, have the defective phone repaired by your maintainer. If the known working phone does not operate properly, check the PABX System and the internal extension wiring.
- Keep the unit away from heating appliances and electrical noise generating devices such as fluorescent lamps and motors.
- The unit should be kept free of dust, moisture and vibration, and should not be exposed to direct sunlight.
- Do not use benzine, thinner, or any abrasive powder to clean the cabinet. Wipe it with a soft cloth.
- Do not disassemble this unit. Dangerous electrical shock could result. The unit must only be disassembled and repaired by qualified service technicians.
- When a failure occurs which exposes any internal parts, disconnect the telephone line and mains supply immediately and return the unit to your maintainer.
- This unit is designed to be installed under controlled conditions of ambient temperature and a relative humidity.
- Avoid installing the unit in damp or humid environments, such as bathrooms or swimming pools.
- 999 or 112 can be dialled on the product after accessing the CO line for the purpose of making outgoing calls to the BT emergency (999) and (112) services.

WARNING:

TO PREVENT THE RISK OF FIRE OR ELECTRIC SHOCK, DO NOT EXPOSE THIS PRODUCT TO RAIN OR ANY TYPE OF MOISTURE.

THIS HANDSET EARPIECE IS MAGNETISED AND MAY RETAIN SMALL FERROUS OBJECTS.

IMPORTANT NOTICE:

Under power failure conditions, this telephone may not operate. Please ensure that a separate telephone, not dependent on local power, is available for use in an emergency.











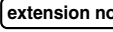



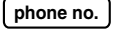







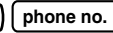









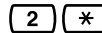
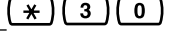
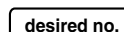

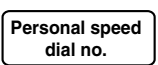
Notes:

- In this manual, the suffix of each model number is omitted.
- For further information, refer to the Main Unit/PABX Manuals.

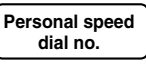



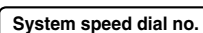





Features List

 Outside (CO) Line button  Off-hook  On-hook  Feature number  Talk









* "Location of Controls" is shown on page 8.

Desired Function	Operation
Making Calls	
Calling	<p>To an extension  ►  ► </p> <p>To an external party  ►  ►  ► </p>
Redial	 ►  ► 
One-touch Dialling	<p>To program</p> <p> ►  ►   ►  ► </p>
	<p>To dial</p> <p> ►  - assigned as a One-touch dialling button ► </p>
Calling an operator	 ►  ► 
Personal Speed Dialling	<p>To set</p> <p> ►  <input type="checkbox"/> KX-TE Series  <input type="checkbox"/> KX-TDA Series</p> <p>(Check the type of your Main Unit.)</p> <p>►  ►  ► </p> <p>(TE: max. 24 digits) (TDA: max. 32 digits)</p> <p>►  ►</p> <p>[TE: 0-9 TDA: 00-99 (Default: 00-09)]</p>
	<p>To dial</p> <p> ►  <input type="checkbox"/> KX-TE Series  ►  <input type="checkbox"/> KX-TDA Series</p> <p>(Check the type of your Main Unit.)</p> <p>►  ► </p> <p>[TE: 0-9 TDA: 00-99 (Default: 00-09)]</p>
System Speed Dialling	<p>To dial</p> <p> ►  ►  ► </p> <p>[TE: 00-99 TDA: 000-999]</p>



























































Features List

Desired Function	Operation	
Receiving Calls		
Hands-free answerback (KX-T7720/T7730 only)	<i>While on-hook</i> 	
Picking up a call	<div style="border: 1px dashed black; padding: 10px;"> <p>Directed</p> <p> <input type="checkbox"/> KX-TE Series [4] ▶ extension no. </p> <p> <input type="checkbox"/> KX-TDA Series [* 4 1] ▶ extension no. </p> <p>Group</p> <p> <input type="checkbox"/> KX-TE Series [4 0] ▶ extension no. </p> <p> <input type="checkbox"/> KX-TDA Series [* 4 0] ▶ group no. </p> <p>(Check the type of your Main Unit.)</p> </div>	
When the Dialed Extension is Busy/No Answer		
Automatic Callback Busy	<p>To set <i>While hearing a busy tone</i></p> <p>[6] ▶ </p> <p>To answer <i>If you hear callback ringing</i></p> <p></p>	
Message Waiting	Sender	<p>To leave a notification</p> <p> ▶ </p> <hr/> <p>To cancel a notification</p> <p> <input type="checkbox"/> KX-TE Series extension no. ▶  ▶  </p> <p> <input type="checkbox"/> KX-TDA Series [* 7 0 0] ▶ extension no. </p> <p>(Check the type of your Main Unit.)</p>
	Receiver	<p>To call back</p> <p> ▶  ▶ </p> <hr/> <p>To clear all notifications</p> <p> <input type="checkbox"/> KX-TE Series [7 0 0] ▶ # </p> <p> <input type="checkbox"/> KX-TDA Series [* 7 0 0] ▶ receiver's extension no. </p> <p>(Check the type of your Main Unit.)</p>





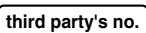



Features List

Desired Function	Operation	
When the Dialed Extension is Busy/No Answer		
Call Waiting	Sender	<p><i>While hearing a busy tone</i></p> <div style="display: flex; align-items: center;"> <div style="border-left: 1px solid black; border-right: 1px solid black; padding: 0 10px;"> <input type="checkbox"/> 2 KX-TE Series <input type="checkbox"/> 1 KX-TDA Series </div> <div style="margin-left: 20px;"> <p>▶ Wait for an answer. ▶ </p> <p>(Check the type of your Main Unit.)</p> </div> </div>
	Receiver	<div style="border: 1px dashed black; padding: 10px;"> <p><input type="checkbox"/> KX-TE Series</p> <p>For outside calls</p> <div style="display: flex; align-items: center;"> <div style="border-left: 1px solid black; border-right: 1px solid black; padding: 0 10px;"> <input type="checkbox"/> 7 3 1 1 # Set <input type="checkbox"/> 7 3 1 0 # Cancel </div> </div> <p>For intercom calls/doorphone calls</p> <div style="display: flex; align-items: center;"> <div style="border-left: 1px solid black; border-right: 1px solid black; padding: 0 10px;"> <input type="checkbox"/> 7 3 2 1 # Set <input type="checkbox"/> 7 3 2 0 # Cancel </div> </div> </div> <div style="display: flex; align-items: center; margin-top: 10px;"> <div style="margin-right: 10px;">  ▶ </div> <div style="border: 1px dashed black; padding: 10px;"> <p><input type="checkbox"/> KX-TDA Series</p> <p>For outside calls</p> <div style="display: flex; align-items: center;"> <div style="border-left: 1px solid black; border-right: 1px solid black; padding: 0 10px;"> <input type="checkbox"/> * 7 3 2 1 Set <input type="checkbox"/> * 7 3 2 0 Cancel </div> </div> <p>For intercom calls</p> <div style="display: flex; align-items: center;"> <div style="border-left: 1px solid black; border-right: 1px solid black; padding: 0 10px;"> <input type="checkbox"/> * 7 3 1 1 Set <input type="checkbox"/> * 7 3 1 0 Cancel </div> </div> </div> <div style="margin-left: 10px;"> <p>▶ </p> <p>(Check the type of your Main Unit.)</p> </div> </div>
<p>To talk to the new party (While hearing the Call Waiting tone)</p> <div style="display: flex;"> <div style="flex: 1;"> <p>Terminating a current status</p> <div style="display: flex; align-items: center;">  ▶  ▶  </div> </div> <div style="flex: 1; border-left: 1px dashed black; padding-left: 10px;"> <p>Holding a current status (outside call)</p> <div style="display: flex; align-items: center;"> <div style="border: 1px solid black; border-radius: 10px; padding: 2px 10px; margin-right: 5px;">HOLD</div> <div style="margin-right: 5px;">▶</div> <div style="display: flex; align-items: center;"> <div style="border: 1px solid black; border-radius: 10px; padding: 2px 5px; margin-right: 5px;">CO</div> <div style="margin-right: 5px;">/</div> <div style="border: 1px solid black; border-radius: 10px; padding: 2px 5px; margin-right: 5px;">INTERCOM</div> </div> <div style="margin-right: 5px;">▶</div>  </div> <p>Holding a current status (extension)</p> <div style="display: flex; align-items: center;"> <div style="border: 1px solid black; border-radius: 10px; padding: 2px 10px; margin-right: 5px;">HOLD</div> <div style="margin-right: 5px;">▶</div>  </div> </div> </div>		

Features List

Desired Function	Operation				
During a Conversation					
Holding a call	Holding  ► 	To retrieve a call at the holding extension  ►  /  ► 			
	To retrieve an outside call from another extension  ►  ► 				
Holding a call exclusively	Holding  ►  ► 	To retrieve a call on exclusive hold  ►  /  ► 			
Transferring a call	 ► <table border="1" data-bbox="406 547 574 627"> <tr> <td>extension no.</td> </tr> <tr> <td> phone no.</td> </tr> </table>	extension no.	 phone no.	to an extension to an external party ►  Announce. ► 	
extension no.					
 phone no.					
Useful Features					
Paging	To page <input type="checkbox"/> KX-TE Series <div style="border: 1px dashed black; padding: 5px; display: inline-block;"> All extensions    Group    All external speakers   All extensions & external speakers    </div> ►  Announce.				
	<input type="checkbox"/> KX-TDA Series  ►     ►  Announce. <p>You can make a voice announcement to extensions or external speakers or both in the preset group simultaneously.</p> To answer an announced page <div style="border: 1px dashed black; padding: 5px; display: inline-block;"> Through a telephone speaker <table border="1" data-bbox="395 1289 764 1385"> <tr> <td> </td> <td><input type="checkbox"/> KX-TE Series</td> </tr> <tr> <td>  </td> <td><input type="checkbox"/> KX-TDA Series</td> </tr> </table> </div> ►  (Check the type of your Main Unit.)		 	<input type="checkbox"/> KX-TE Series	  
 	<input type="checkbox"/> KX-TE Series				
  	<input type="checkbox"/> KX-TDA Series				
Three-party conference	 ►  ►  ► 				

Features List

Desired Function	Operation
Useful Features	
Setting Absent Message	 ▶ [7 5 ▶ message no. <input type="checkbox"/> KX-TE Series] [* 7 5 0 ▶ message no. <input type="checkbox"/> KX-TDA Series] (Check the type of your Main Unit.) ▶ [parameter (if required)] ▶ # ▶ 
Forwarding a call	<input type="checkbox"/> KX-TE Series  ▶  ▶ [All calls (1) ▶ extension no. Busy/No answer (2) ▶ extension no. To an outside line (3) ▶ line access code ▶ phone no. ▶ # ▶  Follow Me (5) ▶ your extension no. Follow Me Cancel (8) ▶ your extension no. Cancel (0)] <input type="checkbox"/> KX-TDA Series  ▶ * 7 1 [0 Both calls 1 Outside calls ▶ 2 Intercom calls] ▶ [All calls (2) ▶ extension no. ▶ # Follow Me (7) ▶ your extension no. Busy (3) ▶ extension no. ▶ # Follow Me Cancel (8) ▶ your extension no. No answer (4) ▶ extension no. ▶ # Cancel (0) Busy/No answer (5) ▶ extension no. ▶ #] (Check the type of your Main Unit.)
Clearing the setting	 ▶ [7 9 # <input type="checkbox"/> KX-TE Series] [* 7 9 0 <input type="checkbox"/> KX-TDA Series] ▶  (Check the type of your Main Unit.)

Features List

Desired Function	Operation
Useful Features	
Log-in/Log-out	<div style="border: 1px dashed black; padding: 10px;"> <p><input type="checkbox"/> KX-TE Series</p> <p>[7 3 6 0 #] For Log-in</p> <p>[7 3 6 1 #] For Log-out</p> <p><input type="checkbox"/> KX-TDA Series</p> <p>[* 7 3 6 1] For Log-in</p> <p>[* 7 3 6 0] For Log-out</p> <p>[ICD Group* extension no.] Specified</p> <p>[*] All</p> <p>* ICD Group: Incoming Call Distribution Group (Check the type of your Main Unit.)</p> </div>
Do Not Disturb (DND)	<p><input type="checkbox"/> KX-TE Series</p> <p> [4 Set] [0 Cancel] # </p> <p><input type="checkbox"/> KX-TDA Series</p> <p> [* 7 1] [0 Both calls] [1 Outside calls] [2 Intercom calls] [1 Set] [0 Cancel] </p> <p>(Check the type of your Main Unit.)</p>
Locking your extension	<div style="border: 1px dashed black; padding: 10px;"> <p><input type="checkbox"/> KX-TE Series</p> <p>[7 7 lock code lock code] # Lock</p> <p>[7 7 lock code] # Unlock</p> <p><input type="checkbox"/> KX-TDA Series</p> <p>[* 7 7 1] Lock</p> <p>[* 7 7 0] extension PIN* Unlock</p> <p>* PIN: Personal Identification Number (Check the type of your Main Unit.)</p> </div>

* Consult your dealer for more details about the feature access numbers.

Location of Controls

RINGER Volume Selector

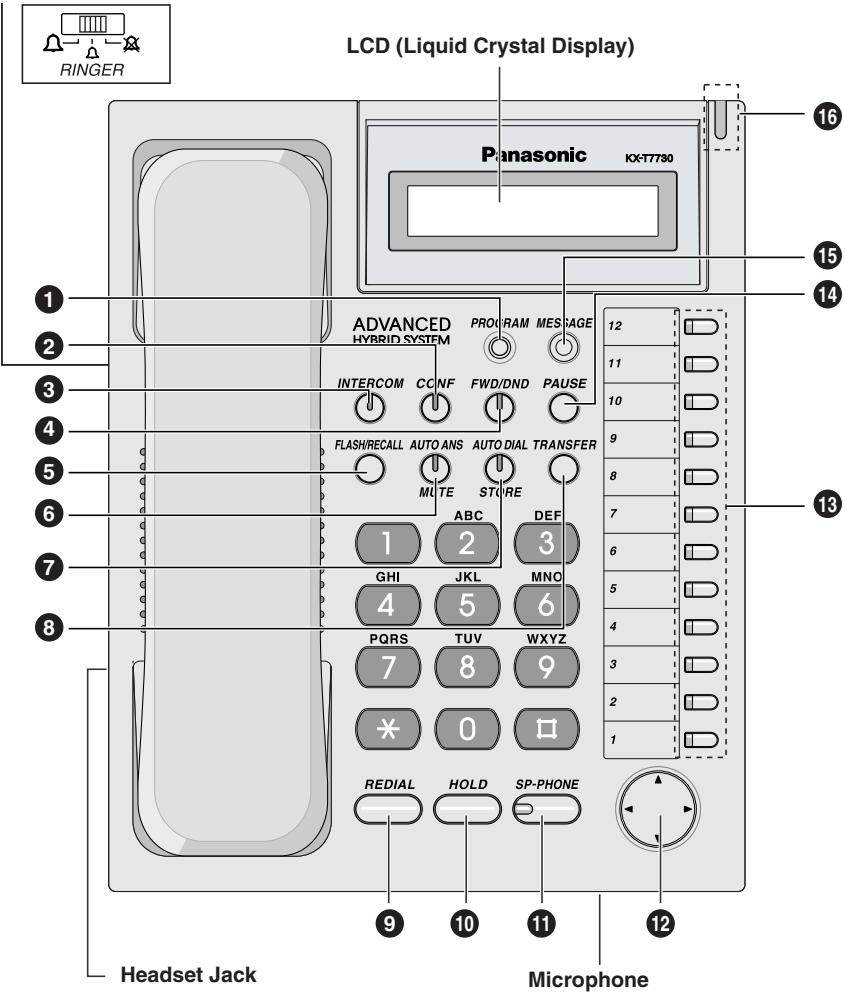

- * The KX-T7750 does not have a microphone.
 - * The display and headset jack are only available on the KX-T7730.
 - * Headset (not included)
- Not available: KX-T7090

Location of Controls

- 1 **PROGRAM:** Used to enter and exit the programming mode.
- 2 **CONF (Conference):** Used to establish a multiple party conversation.
- 3 **INTERCOM:** Used to make or receive intercom calls.
- 4 **FWD/DND (Call Forwarding/Do Not Disturb):** Used to perform Call Forwarding or Do Not Disturb.
- 5 **FLASH/RECALL:** Used for External Feature Access or to disconnect the current call and make another call without hanging up.
- 6 **AUTO ANS (Auto Answer) (KX-T7720/7730):** Used to receive an incoming call in the hands-free mode.
MUTE (KX-T7720/7730): Used to mute the microphone during a conversation.
VOICE CALL (KX-T7750): Used to receive a notification via monitor in place of ringing.
- 7 **AUTO DIAL/STORE:** Used for speed dialling or storing program changes.
- 8 **TRANSFER:** Used to transfer a call to another party.
- 9 **REDIAL:** Used to redial.
- 10 **HOLD:** Used to place a call on hold.
- 11 **SP-PHONE (Speaker Phone) (KX-T7720/7730):** Used for the handsfree operation.
MONITOR (KX-T7750): Used for handsfree dialling. You can monitor the other party's voice handsfree.
- 12 **Navigator Key (KX-T7730):** Used to adjust the volume and the display contrast or select desired items for each function.
Volume Key (KX-T7720/7750): Used to adjust the volume.
- 13 **Flexible Outside (CO) Line Button:** Used to make or receive an outside call. Pressing this button seizes an idle outside line automatically. (Button assignment is required.) Also used as function buttons. (Button assignment is required.)
- 14 **PAUSE:** Used to insert a pause during dialling.
- 15 **MESSAGE:** Used to leave a message waiting indication or call back the party who left the message waiting indication.
- 16 **Message/Ringer Lamp:** The Message/Ringer lamp informs you visually that you have a message or a call.
 - When you receive a call, the lamp flashes depending on the ringing pattern. When someone has left you a message, the lamp is lit continuously. When the ringing pattern is set to Single (Slow flash), Double (Moderate flash), or Triple (Rapid flash) in your PABX, the lamp flashes. When the other ringing patterns are set in your PABX, the lamp may not flash. (e.g., S-Double, Call Waiting Tone1).

Initial Settings

◆ Speaker volume *

While on-hook or during a conversation



Press **SP-PHONE**. Press **Up** or **Down**.

◆ Handset/Headset volume *

While using the handset or headset



Press **Up** or **Down**.

◆ Ringer volume

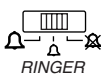

Slide the lever of the **RINGER** Volume Selector to the desired setting (**HIGH/LOW/OFF**).

◆ Display contrast *

KX-T7730

While on-hook or receiving a call



Press **Left** or **Right**.

* The above settings may return to default settings if the telephone line cord is disconnected or the main unit's power is interrupted.

Connection

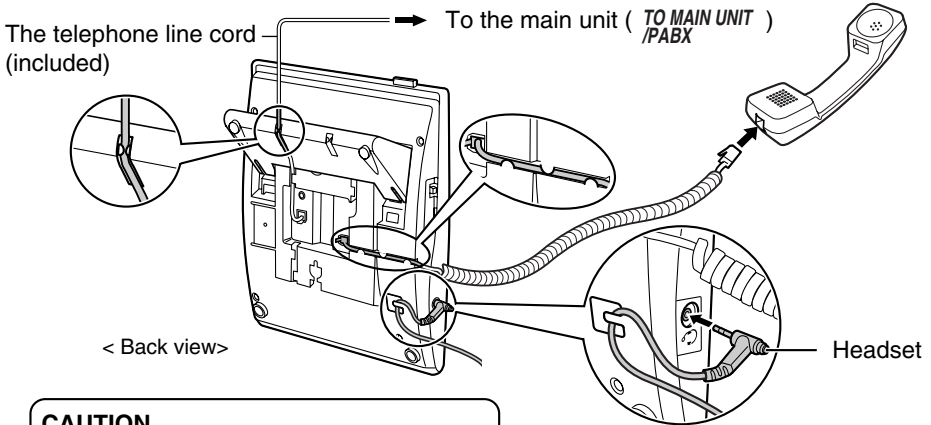

CAUTION

Ensure the cord is inserted in the groove to prevent damage to the connector.

Wall Mounting

1 Pull down the handset hook until it locks, so the tab holds the handset.

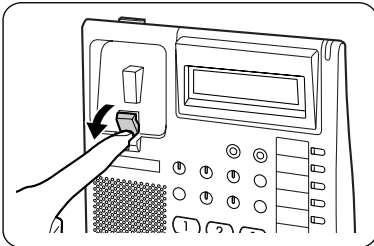

3 Mount the unit on the wall.

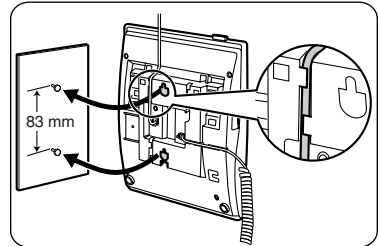

2 Remove the attached stand.

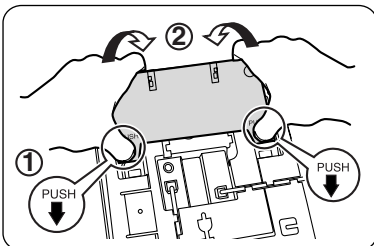

To temporarily place the handset down during a conversation, hook it over the top edge of the phone as shown.

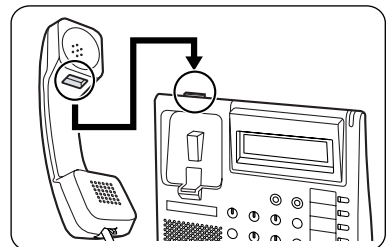

* KX-T7730 model illustrated on this page.

Other Information:

This unit is capable of being used in conjunction with hearing aids fitted with inductive coil pick-ups. The handset should be held as for normal conversation. For operation the hearing aid should be set to its "T" position or as directed in the operating instructions for the hearing aid.



Included Accessories:

Accessory	Qty	White Model	Black Model
Handset	1	PQJX2PSL01Z	PQJX2PKAL01Z
Handset Cord	1	PSJA1084Z	PSJA1084X
Telephone Line Cord	1	PSJA1064Z	PSJA1064Z
Stand	1	PSYL1002Z1	PSYL1002Z2
Overlay*	1	PSGD1066Z	PSGD1066Z

*The overlay is only available on the KX-T7730.



This product is intended to be connected to Panasonic KX series PABX only. Panasonic Communications Company (U.K.) Ltd. declares that this equipment is in compliance with the essential requirements and other relevant provisions of Radio & Telecommunications Terminal Equipment (R&TTE) Directive 1999/5/EC. Declarations of Conformity for the relevant Panasonic products described in this manual are available for download by visiting: <http://www.doc.panasonic.de>

Contact:
Panasonic Services Europe
a Division of Panasonic Marketing Europe GmbH
Panasonic Testing Centre
Winsbergring 15, 22525 Hamburg, Germany

Panasonic Business Systems U.K.

Panasonic House, Willoughby Road, Bracknell, Berkshire RG12 8FP

© 2002 Panasonic Communications Co., Ltd. All Rights Reserved.

PSQW1804VA KU0302YK4046